

EH90/ EH99

INSTRUCTIONS FOR USE

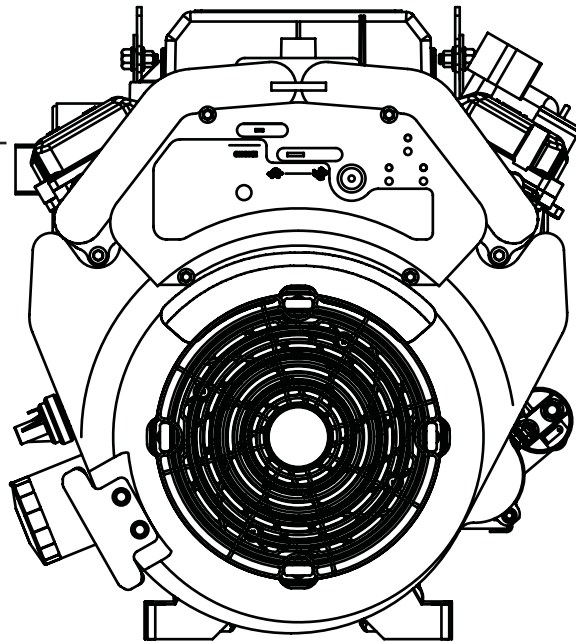

OHV Gasoline Engine

EMD-EU9099
September 2013

FORWARD

Thank you for choosing a Subaru. Your Subaru engine can supply the power to operate various sorts of machines and equipment. Keep this owner's manual at hand, so you can refer to it when needed.

Due to constant efforts to improve our products, certain procedures and specifications are subject to change without notice. When ordering spare parts, always give us the MODEL, SPECIFICATION (PRODUCT) NUMBER and SERIAL NUMBER of your engine.

Please fill in the blanks below after checking the product number on your engine.
(Location of label is different depending on the engines specification.)

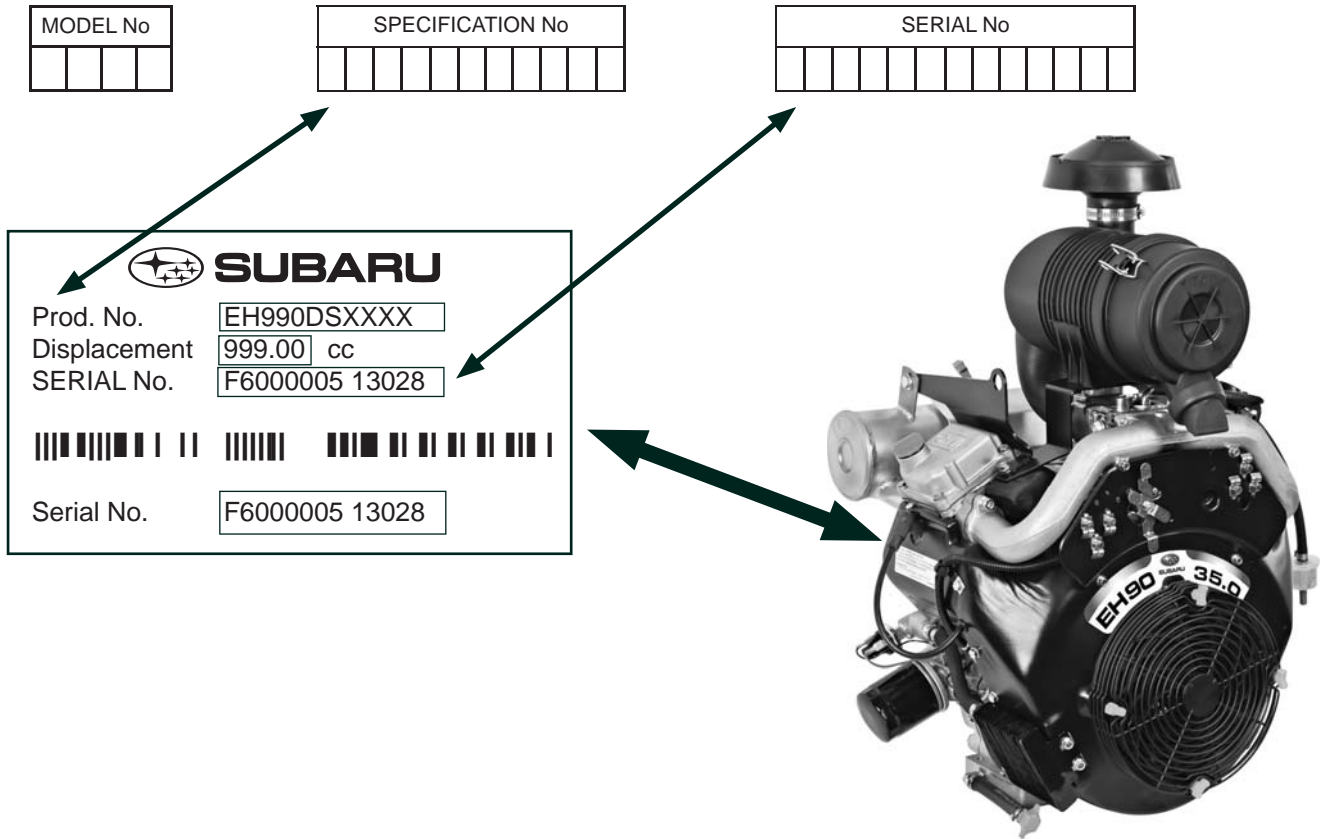

PRODUCT REGISTRATION

Please take a moment to register your product to ensure easy warranty qualification and product updates.









Please register online at: www.SubaruPower.com/register

You will need the above three pieces of information to complete your product registration.





CONTENTS





















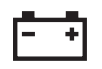

SAFETY PRECAUTIONS	5
GENERAL INFORMATION	7
BATTERY INSTALLATION	8
OPERATING YOUR ENGINE	8
GENERAL MAINTENANCE	10
MAINTENANCE SCHEDULE	14
PREPARATIONS FOR STORAGE	15
SPECIFICATIONS.....	16
EASY TROUBLESHOOTING	16
WIRING DIAGRAM	17
WARRANTY.....	18

SYMBOLS

	Read manual.		Shut off fuel valve when the engine is not in use.
	Stay clear of the hot surface.		Check for leakage from hose and fittings.
	Exhaust gas is poisonous. Do not operate in an unventilated room or enclosed area.		Fire, open flame and smoking prohibited.
	Stop the engine before refueling.		HOT, avoid touching the hot area.

USA and CANADA only

	Read INSTRUCTIONS FOR USE before use.		The engine emits toxic gas that can kill you in minutes. Do not run in an enclosed area.		Hot surface can burn you. Stay away if engine has been running.
	Gasoline is extremely flammable and its vapors can explode. <ul style="list-style-type: none"> • Stop the engine before refueling. • Check for leakage from hoses and fittings. • Shut off fuel valve when the engine is not in use. 				

	On (Run)		Engine start (Electric start)		Fuel (gasoline)
○	Off (Stop)		Engine stop		Fuel (diesel)
	Engine oil		Cold engine		Fuel shut-off
	Add oil		Warm engine		Fuel system failure / malfunction
	Battery		Electrical preheat (Low temperature start aid)		Choke
	Fast		Run position		Plus ; positive polarity
	Slow		Stop position		Minus ; negative polarity
	Primer		Push primer		Do not push primer
2X	Two times				

SAFETY PRECAUTIONS

The safety alert symbol (▲) is used with a signal word (**DANGER, CAUTION, WARNING**), a pictorial and/or a safety message to alert you to hazards.

DANGER indicates a hazard which, if not avoided, will result in death or serious injury.

WARNING indicates a hazard which, if not avoided, could result in death or serious injury.

CAUTION indicates a hazard which, if not avoided, might result in minor or moderate injury.

NOTE indicates a situation that could result in engine damage. Follow safety messages to avoid or reduce the risk of injury or death.

The manufacturer cannot possibly anticipate every possible circumstance that might involve a hazard. The warnings in this manual, and the tags and decals affixed to the unit are, therefore, not all-inclusive. If you use a procedure, work method or operating technique that the manufacturer does not specifically recommend you must satisfy yourself that it is safe for you and others. You must also make sure that the procedure, work method or operating technique that you choose does not render the engine system unsafe.

These safety warnings cannot eliminate the hazards that they indicate. Common sense and strict compliance with the special instructions while performing the action or service are essential to preventing accidents.

Study these **RULES FOR SAFE OPERATION** carefully before operating or servicing this equipment. Become familiar with the **OWNER'S MANUAL** and with the engine. The engine can operate safely, efficiently and reliably only if it is properly operated and maintained. Many accidents are caused by failing to follow simple and fundamental rules or precautions.

▲ DANGER	
	<p>A running engine gives off carbon monoxide, an odorless, colorless, poison gas.</p> <p>Breathing carbon monoxide can cause headache, fatigue, dizziness, vomiting, confusion, seizures, nausea, fainting or death.</p>
<ul style="list-style-type: none">• Operate engine ONLY outdoors.• Keep exhaust gas from entering a confined area through windows, doors, ventilation intakes, or other openings.	

CALIFORNIA PROPOSITION 65 WARNING
Engine exhaust and some of its constituents are known to the State of California to cause cancer, birth defects and other reproductive harm.

CALIFORNIA PROPOSITION 65 WARNING
This product contains or emits chemicals known to the State of California to cause cancer, birth defects and other reproductive harm.

SAFETY PRECAUTIONS

BEFORE OPERATING

- Gasoline is highly **FLAMMABLE** and its vapors are **EXPLOSIVE**. Do not permit smoking, open flames, sparks or heat in the area while handling gasoline. Avoid spilling gasoline on a hot engine. Comply with all of the laws regulating storage and handling of gasoline.
- Store gasoline and other fuels only in containers designed and approved for the storage of such materials.
- Pressure can build up in the fuel tank. Loosen the fuel cap slowly to relieve any pressure in the tank.
- Add gasoline and other fuels in a clean, well-ventilated area. Wipe up any spilled gasoline immediately. If gasoline has been spilled, let it dry completely before starting the engine.
- Do not overfill the fuel tank. Always allow room for fuel expansion. If the tank is overfilled, the fuel can overflow onto a hot engine and cause a **FIRE** or an **EXPLOSION**.
- Thoroughly inspect the engine for loose or damaged parts before each use. Do not use the engine until adjustments or repairs are made.
- Check the oil level in the engine before each use.
- Inspect the engine periodically. Repair or replace all damaged or defective parts immediately.
- Inspect fuel system frequently for leaks or damage. Repair or replace any damaged or leaking component immediately. Never attempt to change, alter or modify the engine fuel system in any way that might affect safety or compliance with applicable codes and standards.
- This engine requires an adequate flow of cooling air for its continued proper operation. Never operate the equipment inside any room or enclosure where the free flow of cooling air into and out of the equipment might be obstructed. Without sufficient cooling air flow, the engine quickly overheats, damaging the engine or nearby property.
- Do not smoke around the engine. Wipe up any fuel or oil spills immediately. Never leave oily or fuel soaked rags around the engine. Keep the area around the engine clean and free of debris.
- Keep hands, feet, clothing, etc., away from moving parts of this engine.
- Never operate the engine (a) in the rain; (b) in any enclosed compartment; (c) if the engine speed changes; (d) if the engine sparks; (e) if flame or smoke is observed while the engine is running.
- Never work on this engine or handle any electrical device while standing in water, while barefoot, or while hands or feet are wet. **DANGEROUS ELECTRIC SHOCK** will result.
- Allow muffler, engine cylinder and fins to cool before touching.
- Remove accumulated combustibles from muffler area and cylinder area.
- Install and maintain in working order a spark arrester before using equipment on forest covered, grass covered, brush covered unimproved land.

WHILE OPERATING

- This engine was designed and manufactured for specific applications. Do not attempt to modify the equipment or use it for any application for which it was not designed.
- Engine exhaust gases contain **DEADLY** carbon monoxide gas. This dangerous gas, if breathed in sufficient concentrations, can cause unconsciousness or even death. Operate this equipment only in the open air where adequate ventilation is available.
- Do not insert any object through the cooling slots of the engine. This could damage the equipment or injure personnel.
- Do not operate the engine faster than the speed necessary to operate the equipment. Do not run the engine at high speed when not operating the equipment.

SERVICE INFORMATION

Service on this engine within and after the warranty period can be performed by any authorized Subaru service dealer. When contacting an authorized Subaru service dealer about parts and service, always supply the complete model number and serial number of the unit as shown on the specification label.

The warranty for this engine is included in the back of the owner's manual.

GENERAL INFORMATION

OIL AND FUEL INFORMATION

NOTE:

Be sure to read these instructions carefully before attempting to start or operate this equipment. Using old or improper oil or fuel can cause engine damage.

⚠ CAUTION

- ⚠ Any attempt to crank or start the engine before it has been properly serviced with the recommended oil may result in engine damage.
- ⚠ This engine is shipped from the manufacturer without oil. Check oil level before starting engine. The engine will be damaged beyond repair and will not be covered under warranty if started without oil.

Use only high quality detergent oil rated with an API service classification SJ or higher. **DO NOT** use oil designated "For Diesel Engines Only". The use of a multi-weight oil (10W-30) may result in higher than normal oil consumption. Therefore, checking the oil level more frequently may be required.

The recommended oil weights include the following:

- During summer months: SAE30. An acceptable substitute is SAE 10W-30. After first oil change, synthetic oil is acceptable.
- During winter months: SAE 5W-30, or after the first oil change, synthetic 5W-30 can be used. **DO NOT USE SAE 10W-40.**

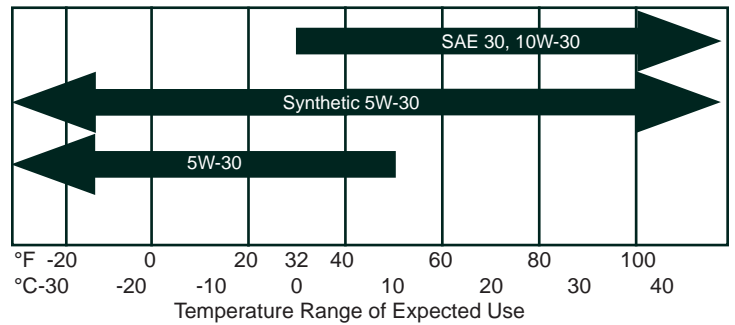

RECOMMENDED OIL TYPE

Using the proper type and weight of oil in the crankcase is extremely important. Check the oil before each use and change the oil regularly (see Figure 1). Failure to use the correct oil, or using dirty oil, can cause premature engine wear and failure.

OIL CAPACITY: 1.8 liters (1.9 qts/73.6 ounces)

Figure 1



CHANGE OIL

Use no special additives. Make sure that the unit is level when filling with oil. **DO NOT OVERFILL.**

IMPORTANT: DO NOT OVERFILL. Check and maintain oil level regularly. Change oil and filter after first eight (8) hours of operation. Thereafter, change oil and filter every 100 hours of operation. Change oil more often if engine is operated in dirty or dusty conditions or if engine is operated under heavy loads or in high ambient air temperatures.

RECOMMENDED FUEL TYPE

The fuel tank is provided separately from the Equipment manufacturer.

⚠ CAUTION

Do not overfill the fuel tank. Always allow room for fuel expansion.

▲ WARNING

Never fill the fuel tank indoors, or when the engine is running or hot. Wait 1 minute before refilling. Do not light a cigarette or smoke when filling the fuel tank.

NOTE: THE ENGINE IS CERTIFIED TO OPERATE ON AUTOMOTIVE UNLEADED GASOLINE, WITH NO MORE THAN 10% ETHANOL (E10). DO NOT USE E15 OR E85.

NOTE: Using a fuel additive such as STA-BIL® fuel stabilizer, or an equivalent, will delay gum deposits from forming in the engine's fuel system.

It is also recommended that gasoline be purchased in small quantities, not more than a 30 day supply. FRESH gasoline minimizes gum deposits, and also will ensure fuel volatility tailored for the season in which the engine will be operated.

RECOMMENDED BATTERY

Servicing the battery is to be performed or supervised by personnel knowledgeable of batteries and the required precautions. Keep unauthorized personnel away from batteries. Use only 12 volt negative (-) ground batteries with a minimum rating of 450 cold-cranking amps at -17.8C (O F) (OEM requirements may differ).

The battery and battery cables are not provided with the engine from Subaru. If this engine was purchased as part of a piece of equipment, the battery and cables may have been supplied by the equipment manufacturer.

▲ WARNING

Damage will result to the engine starter if a battery rated less than 450 cold-cranking amps is used.

BATTERY CABLES

Using battery cables that are too long or too small in diameter may cause a decrease in voltage which leads to a starting problem due to voltage drop. Use a cable size "2" for length up to 10 feet. See Figure 2 for battery cable connections.

Figure 2

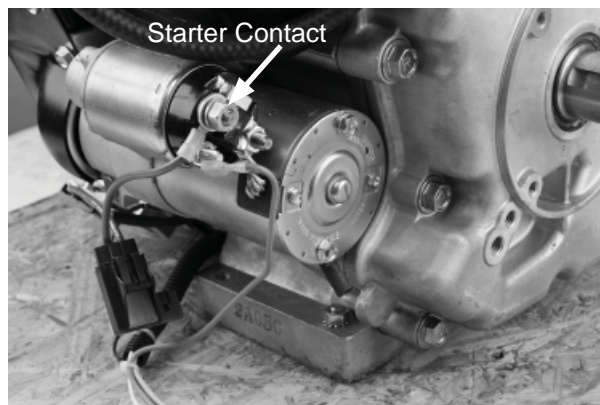

OPERATION AND MAINTENANCE

It is the owner's/operator's responsibility to perform all safety checks; to make sure that all maintenance for safe operation is performed promptly; and to have the engine checked by an authorized dealer periodically. Normal maintenance service and replacement of parts are the responsibility of the owner/operator and, as such, are not considered defects in material or workmanship within the terms of the warranty. Individual operating habits and usage contribute to the need for maintenance service.

Proper maintenance and care of the engine assures a minimum number of problems and keeps operating expenses at a minimum. See an authorized Subaru dealer/distributor for service aids and accessories.

BEFORE STARTING THE ENGINE

Perform the following tasks before trying to start the engine:

Checking and Adding Engine Oil:

NOTE: When adding oil to the engine crankcase, use only high quality detergent oil rated with API service classification SJ (or higher). Use no special additives.

Select the oil's viscosity grade according to the expected operating temperature. Do not use SAE 10W-40.

Check engine oil level frequently to avoid possible damage from running low on oil.

- Place engine on level surface.
- Clean area around oil fill and remove oil fill cap and dipstick.
- Wipe dipstick clean. Reinstall and check oil level on dipstick. (Figure 3)

Figure 3

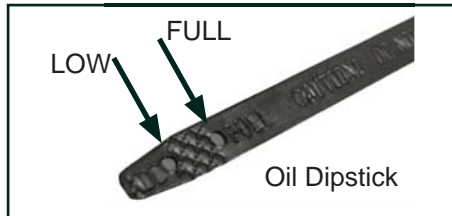

- Slowly fill engine with oil through the oil fill opening until it reaches the full mark on the dipstick. Stop filling, occasionally to check oil level. **DO NOT OVERFILL.**
- Install dipstick. Install oil fill cap and finger tighten securely.
- Check engine oil level before starting each time thereafter.

STARTING THE ENGINE

- 1 Open the fuel shut-off valve, (if equipped)
- 2 Move choke control to Choke or Start position.
- 3 Push throttle to Fast position (if equipped). Operate the engine with the throttle in Fast position.
- 4 Turn key to Start position (hold until engine starts, but not more than 5 seconds). To prevent damage to starter, allow starter to cool for one minute between attempting to restart.
- 5 A) If the engine **FAILS TO START**, go to Step 6
B) If the engine **STARTS**, go to Step 7
- 6 Push the choke lever to the **HALF CHOKE POSITION**. Repeat step 4.
 - If the engine **STILL FAILS TO START**, repeat Steps 1-5.
- 7 Once the engine starts move the choke lever to the **Off POSITION** by pushing it in or move choke control to Run position. Allow engine to warm up for two minutes.

NOTE: For cold weather starting: make sure the proper engine oil is being used.

STOPPING THE ENGINE

- 1 Remove load from engine.
- 2 Move throttle to SLOW position.

- 3 While still running, allow engine to cool for two minutes.
- 4 Turn key to OFF position.
- 5 Close fuel shut-off valve (if equipped)

LOW OIL PRESSURE SHUTDOWN

Operation of an engine with low oil pressure will cause significant damage within minutes. This engine is equipped with a low oil pressure sensor that will shut off the engine if the oil pressure drops below the safe operating pressure. If the engine is equipped with the optional Subaru control box, the warning light on the box will turn on and the engine will be shut-down if the oil pressure is too low. If the engine has no Subaru control box the engine will simply shut-down when the oil pressure is too low.

For some applications, such as vehicles, it may be safer to operate the equipment with the low oil pressure shut-off system disabled. To disable the low oil pressure shut-off system, disconnect (pull apart) the White and Blue wire terminals that are located above the Oil Filter and the Oil Pressure Switch. If this engine was purchased as part of an equipment assembly, the equipment manufacturer may have disabled the low oil pressure shut-down system. Please check with your equipment dealer for details.

A low oil pressure condition is typically caused by insufficient oil in the crankcase, contaminated oil, old oil that has not been changed within the recommended service interval or an internal engine problem. Please check with your authorized Subaru engine service dealer for assistance. The low oil pressure shut-down system does not replace proper service and maintenance and the checking of the oil level before the engine is started. **Always check for proper oil level before starting the engine.**

HIGH OIL TEMPERATURE ALARM

Operation of an engine with high oil temperature will cause significant damage within minutes. This engine is equipped with a high oil temperature sensor and alarm system. The oil temperature sensor monitors the oil temperature during engine operation. If the oil temperature exceeds a safe operating condition, a high pitched and pulsating warning alarm will sound.

If the alarm sounds, immediately shut the engine off. Allow the engine to cool and check for the cause of the high engine oil temperature condition. Causes may include low oil level, contaminated oil, blocked air flow across the heads

and cylinders. Please check with your authorized Subaru engine service dealer for assistance. Only operate the engine after it has cooled and the cause of the problem has been corrected. The high oil temperature alarm system does not replace proper service and maintenance and the checking of the oil level and cooling system before the engine is started. **Always check for proper oil level and unobstructed air cooling intake and passages before starting the engine.**

WINTER/SUMMER INTAKE AIR CONTROL (IF SO EQUIPPED)

Under certain weather conditions (temperatures below 40° F (4° C) and a high dew point), the engine may experience icing of the carburetor and/or the crankcase breather system. To eliminate this problem, this engine may be fitted with a winter/summer valve (Figure 4). This directs hot air into the carburetor during cold weather operation. Always make sure the winter/summer valve is in the correct location relative to the weather conditions.

Figure 4



GENERAL MAINTENANCE RECOMMENDATIONS

PERFORMING SCHEDULED MAINTENANCE

It is important to perform service as specified in the Maintenance Schedule for proper engine operation, and to ensure that the engine complies with the applicable emission standards for the duration of its useful life. Service and repairs may be performed by any capable person or repair shop. Additionally, emissions critical maintenance must be performed as scheduled in order for the Emissions Warranty

to be valid. Emissions critical maintenance consists of servicing the air filter and spark plugs in accordance with the Maintenance Schedule.

CHECKING THE OIL LEVEL

See the "BEFORE STARTING THE ENGINE" section for information on checking the oil level. The oil level should be checked before each use, or at least every eight (8) hours of operation. Keep the oil level maintained.



CHANGING THE OIL AND FILTER

The engine is equipped with an oil filter. Change the oil and filter after the **first eight (8) hours** of operation. Change the oil and oil filter **every 100 hours** thereafter. If using this engine under dirty or dusty conditions, or in extremely hot weather, change the oil more often.

Use the following instructions to change the oil while the engine is still warm:

- 1 Clean the area around the oil drain plug, remove the plug and drain the oil completely into a suitable container (Figure 5).

Figure 5

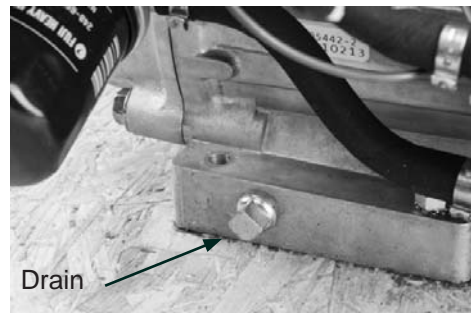

- 2 When the oil is drained, install and tighten the oil drain plug.
- 3 When changing the oil filter, use the following instructions:
 - A Locate filter (Figure 6)

Figure 6



- B Place a suitable container beneath the oil filter and turn the filter counterclockwise to remove the filter.
 - C Coat the gasket of a new filter with engine oil. Turn the new filter clockwise until the gasket contacts the filter adapter, then tighten an additional 3/4 turn.
- 4 Remove the oil fill cap and insert a clean funnel into the oil fill opening. Fill the crankcase with the recommended oil until the oil level is at the full point on the dipstick.
POUR SLOWLY.
- 5 When the crankcase is filled to the proper level, install and tighten the oil fill cap. Start engine to fill oil filter, recheck/correct oil level.

CLEANING INTAKE SCREEN AND COOLING FINS

Inspect and clean the intake screen and the following engine cooling fins: cylinder, cylinder head, oil filter base and oil cooler after each use or as needed. Blow or brush out any debris to help the engine run cooler. Continued operation with a clogged cooling system can cause severe overheating and possible engine damage. Do not pressure wash to avoid shorting and corrosion in the wiring harness, oil pressure switch, solenoid and starter motor (Figure 7).

Figure 7

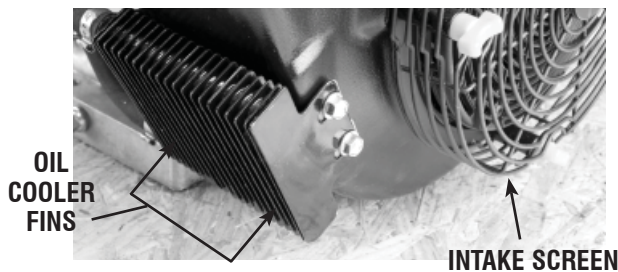

SERVICING THE AIR CLEANER

The engine's air cleaner system is one of the most important

items to maintain. The engine will not run properly and may be damaged if it is run with a dirty air cleaner system.

Service or replace the paper air filter per the "Maintenance Schedule" section. Service or replace the filter more often if the engine is operated under dusty or dirty conditions. Clean the foam pre-filter (if equipped) every 25 hours of operation, or sooner under dusty or dirty conditions.

Use the following instructions to clean or replace the air cleaner components. Locate the engine configuration (figure 8 or 9) and follow the instructions.

▲ CAUTION

Never run this equipment without the complete air cleaner system installed on the engine. This could result in premature wear to the engine.

Flat Top Air Cleaner

To clean or replace foam pre-cleaner (if equipped):

- Remove air cleaner cover, then foam pre-filter.
- Wash pre-cleaner in soapy water. Squeeze pre-filter dry in clean cloth (DO NOT TWIST).
- Add light oil to the foam pre-filter before re-installing on the air filter element.
- Clean air cleaner cover before re-installing it.

To service or replace paper air filter:

- Remove air cleaner cover; then remove foam pre-filter (if equipped) and remove paper filter.
- If the filter is too dirty, replace it with a new one. Dispose of the old filter properly.
- Clean air cleaner cover then slip pre-cleaner over filter (if equipped).
- Next insert new paper filter into the base of the air cleaner. Re-install air cleaner cover.

Figure 8 - Flat Top Air Cleaner

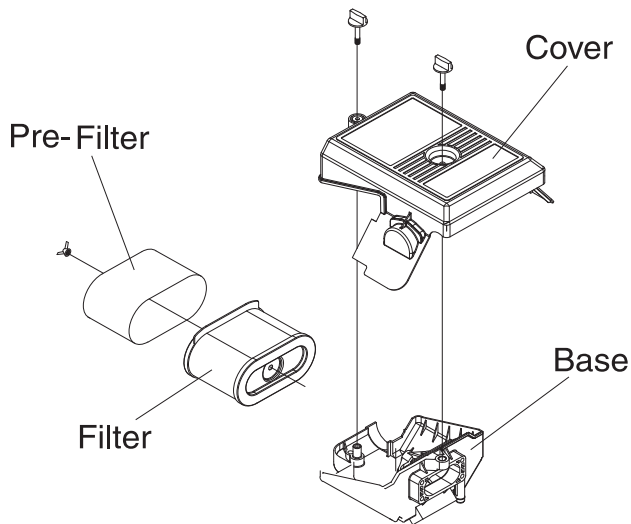

Canister Style Air Cleaner

- Remove air cleaner cover.
- Empty dust out of cover.
- Gently pull filter out of air cleaner housing.
- Clean inside of housing with damp cloth.
- Push new air filter into housing.
- Reinstall the air cleaner cover.

Figure 9 - Canister Style Air Cleaner

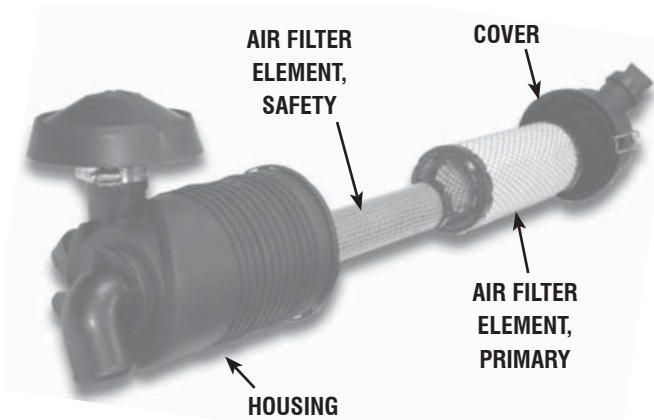

REPLACING AND CLEANING THE SPARK PLUGS

Clean and adjust the spark plug gap every 50 hours of operation. Replace the plugs every 500 hours of operation or once

each year, whichever comes first. This will help the engine to start easier and run better.

- 1 Stop the engine and pull the spark plug wires off of the spark plugs.
- 2 Clean around the spark plugs and remove them from the cylinder head.
- 3 Set the spark plug gap (Figure 10) to 1.1 mm (0.043 in). Install a correctly gapped spark plugs into the cylinder head.

Figure 10

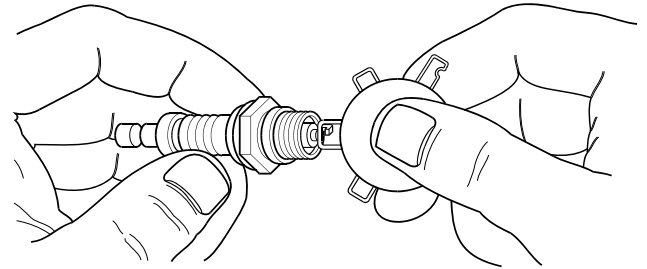

CLEANING SPARK ARRESTOR SCREEN

If the engine exhaust muffler has a spark arrestor screen, inspect and clean the screen **every 100 hours** of operation or once each year, whichever comes first.

NOTE: If using the engine on any forest-covered, brush-covered or grass-covered unimproved land, it must have a spark arrestor. The spark arrestor must be maintained in good condition by the owner/operator.

Clean and inspect the spark arrestor screen as follows:

Inspect the screen and replace if it is torn, perforated or otherwise damaged. **DO NOT USE** a defective screen. If the screen is not damaged, clean it with a commercial solvent.

If the spark arrestor is found to be damaged or worn out, replace it.

SERVICE AND ADJUSTMENTS

ENGINE SPEED

The operating speed of this engine is maintained by a mechanically controlled governor. **DO NOT** try to adjust the governed speed setting for the following reasons:

- Operating the engine at high engine speeds is dangerous and increases the risk of personal injury or damage to the equipment.
- Operating the engine at low engine speeds with heavy loads may shorten the engine's life.

CARBURETOR ADJUSTMENTS

The carburetor of the engine is pre-set at the factory. The carburetor should not be tampered with because it would violate EPA and CARB regulations and **VOID THE EMISSION CONTROL SYSTEM WARRANTY.**

CHECKING AND ADJUSTING VALVE CLEARANCE

Check valve clearance and adjust (if necessary) after the first 50 hours of operation and every 300 hours thereafter.

IMPORTANT: if not qualified for doing this procedure or the proper tools are not accessible, please take the engine/equipment to the nearest Authorized Subaru Service Center to have the valve clearance adjusted. This is a very important step to insure a long life for the engine.

To adjust valve clearance:

- Make sure the engine is at room temperature
- Remove spark plugs and make sure that the spark plug wires are out of the way.
- Remove the four screws attaching the valve cover with a 10 mm wrench or socket.
- Make sure the piston is at Top Dead Center (TDC) of its compression stroke (both valves closed). To get the piston at TDC, remove the intake screen at the front of the engine to gain access to the flywheel nut. Use a ratchet and a 36 mm socket to rotate the engine in a clockwise direction. While watching the piston through the spark plug hole, the piston should be observed moving up after the intake valve closed. The piston is at TDC when it is at its highest point of travel.
- Loosen the rocker jam nut (Figure 11). Use a 10 mm Allen wrench to turn the pivot ball stud while checking clearance between the rocker arm and the valve stem with a feeler gauge. Correct clearance is 0.002-0.004 inch (0.50-0.1mm) for both intake and exhaust valves.

Figure 11

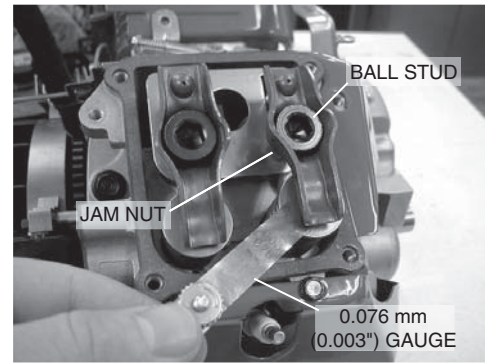

NOTE: The rocker arm jam nut must be held in place as the pivot ball stud is turned.

When the valve clearance is correct, hold the pivot ball stud in place with the Allen wrench and tighten the rocker arm jam nut. Tighten the jam nut to 168 in./lbs. (19 Nm) torque. After tightening the jam nut, recheck valve clearance to make sure it did not change.

- Install new valve cover gasket.
- Re-install the valve cover and torque to 60 in.lbs (6.8 Nm).

NOTE: Start all four screws before tightening, then torque in a crisscross pattern. Make sure the valve cover gasket is in place.

- Repeat the process for the other cylinder.
- Re-install spark plugs.
- Re-attach the spark plug wires to the spark plugs.

MAINTENANCE SCHEDULE

The owner/operator is responsible for making sure that all periodic maintenance tasks are completed on a timely basis; that all discrepancies are corrected; and that the equipment is kept clean and properly stored. Never operate a damaged or defective engine.

▲ CAUTION

Disconnect the spark plug wires from the spark plugs, and place the wires where they cannot come in contact with the spark plugs before working on this engine.

MAINTENANCE SCHEDULE

	Every 8 Hours or Daily	Every 50 Hours or Yearly	Every 100 Hours or Yearly	Every 500 Hours or Yearly	Every 1000 Hours
Clean engine and check bolts and nuts	●(Daily)				
Check for leakage from hoses and fittings	● (Daily)				
Check and refill engine oil	●				
Change engine oil (Note 1)	● (Initial 8 hours)		●		
Replace engine oil filter (Note 1)	● (Initial 8 hours)		●		
Check battery electrolyte fluid level		●			
Adjust spark plugs			●		
Clean foam pre-filter (if equipped)		● (Initial 25 hours)			
Spark arrester (optional part)			●		
Replace Industrial (Donaldson) A/C filter				●	
Replace low profile, (flat top) A/C filter			●		
Replace fuel strainer (filter)				●	
Clean and adjust spark plugs and electrodes		●			
Replace spark plugs				●	
Remove carbon from cylinder heads				●	
Clean carburetor				●	
Clean engine base (oil pan)				●	
Check and adjust valve clearance		● (Initial 50 hours)	● (Initial 300 hours thereafter)		
Replace fuel lines					● (Every 2 years)

Note 1 : Initial oil change and oil filter replacement should be performed after 8 hours of operation. Thereafter change oil and oil filter every hundred (100) hours. Before changing oil, check for a suitable way to dispose of old oil.

Note 2: More frequent oil changing, oil filter replacement and air cleaner service on replacement may be necessary depending on operating conditions. This would include dusty environment, high ambient temperature, heavy engine loading.

STORAGE INSTRUCTIONS

This engine should be started at least once a month and run for at least 10 minutes. If this cannot be done and the equipment must be stored for more than 30 days, use the following guidelines to prepare it for storage.

DANGER

Never store the engine with the fuel in the tank indoors or in an enclosed or poorly ventilated area. Fumes can reach an open flame, spark, or pilot light as on a furnace, water heater, or clothes dryer and ignite.

1. Run the engine for about five (5) minutes to warm it.

NOTE: Alcohol-blended fuel, or ethanol, attracts moisture which can lead to the separation and formation of acids during storage. This acidic gas can damage internal engine parts.

WARNING

Drain the fuel into an approved container, outdoors and away from open flame. Be sure the engine is cool.

NOTE: Using a fuel additive such as STA-BIL® fuel stabilizer, or an equivalent, will delay gum deposits from forming in the engine's fuel system.

2. While the engine is still warm, drain the oil from the crankcase (Figure 5). Refill it with fresh oil. See the "BEFORE STARTING ENGINE" section for oil recommendations.
3. Remove spark plugs and pour about 1/2 ounce (15ml) of engine oil into the cylinders. Crank slowly to distribute oil.

CAUTION

Avoid spray from the spark plug hole when cranking the engine slowly.

4. Install the spark plugs. Do not connect the spark plug wires.
5. Clean dirt, oil and grease from the cylinder, cylinder head, fins, blower housing, rotating screen and muffler area.
6. Close the fuel shut-off valve, if equipped.

OTHER STORAGE TIPS

1. Do not store gasoline from one season to another.
2. Use only plastic containers. Rust and/or dirt in metal gasoline containers can cause problems.
3. Store the equipment in a clean and dry area.

SPECIFICATIONS

Model Name	EH90 / EH99	
Type	Air-Cooled, 4-stroke, V-Twin Cylinder, Horizontal P.T.O. shaft, OHV., Gas Engine	
Bore x Stroke	mm (in)	90 x 78.58 (3.54" x 3.09")
Displacement	999cc (60.96 cu in)	
Rated Output	35hp@3600rpm / 40hp@3600rpm (26.1kw / 29.8kw @3600rpm)	
Direction of Rotation	Counterclockwise as viewed from P.T.O. shaft side	
Starting System	Electric Starter	
Oil Capacity	1.8L (1.9 qts)	
Dry Weight	lb/Kg	104 / 47
Dimension	(L x W x H)	18.45" x 17.23" x 19.15" Flat top Air Cleaner / 18.45 x 17.23 x 28.63 Canister Air Cleaner

TROUBLESHOOTING

PROBLEM	CAUSE	CORRECTION
Engine will not start; or starts and runs rough	<ol style="list-style-type: none"> 1. Dirty air cleaner 2. Out of gasoline 3. Stale gasoline 4. Spark plug wire not connected to spark plug 5. Bad spark plug 6. Water in gasoline 7. Over choking 8. Low oil level 9. Excessive rich fuel mixture 10. Intake valve stuck open or closed 11. Engine has lost compression 	<ol style="list-style-type: none"> 1. Clean or replace air cleaner 2. Fill fuel tank 3. Drain fuel tank and carburetor, fill with fresh fuel 4. Connect wire to spark plug 5. Replace spark plug 6. Drain fuel tank and carburetor, fill with fresh fuel. 7. Put choke knob to NO CHOKE position 8. Fill crankcase to proper level 9. Contact Authorized Service Facility 10. Contact Authorized Service Facility 11. Contact Authorized Service Facility
Engine shuts down during operation	<ol style="list-style-type: none"> 1. Out of gasoline 2. Fault in engine 	<ol style="list-style-type: none"> 1. Fill fuel tank 2. Contact Authorized Service Facility
Engine lacks power	<ol style="list-style-type: none"> 1. Dirty air filter 2. Engine needs to be serviced 	<ol style="list-style-type: none"> 1. Replace air filter 2. Contact Authorized Service Facility
Engine "hunts" or falters	<ol style="list-style-type: none"> 1. Choke is open too soon. 2. Carburetor is running too rich or too lean 3. Governor or speed control system out of adjustment 	<ol style="list-style-type: none"> 1. Move choke to halfway position until engine runs smoothly 2. Contact Authorized Service Facility 3. Contact Authorized Service Facility

WIRING DIAGRAM

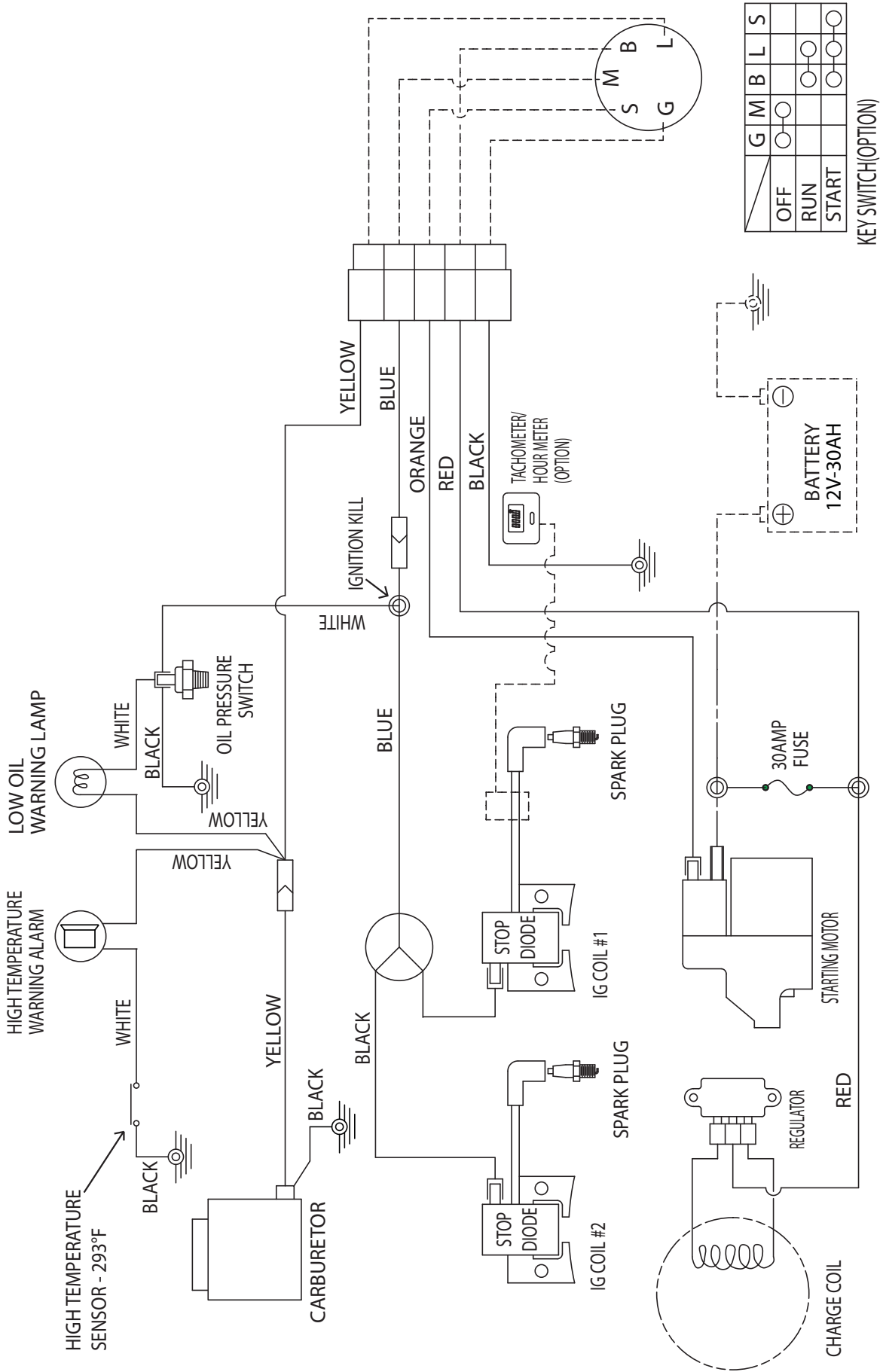

	G	M	B	L	S
OFF	○	○			
RUN			○	○	
START			○	○	○

KEY SWITCH(OPTION)

Limited Engine Warranty

(Effective with engines purchased in U.S.A. and Canada after March 1, 2012)

Subaru Industrial Power Products, a division of Fuji Heavy Industries, Ltd. (herein “Subaru”), warrants that each new engine sold by it will be free, under normal use and service, from defects in material and workmanship for a period listed below from the date of sale to the original retail purchaser. Subaru’s obligation under this Limited warranty shall be limited to the repair and replacement, at Subaru’s option, of any part or parts which upon examination is/are found, in Subaru’s judgment, to have been defective in material or workmanship. It shall be a condition of Subaru’s obligation under this Limited Warranty that Subaru, directly or through one of its Distributors or Service Centers authorized to service the particular engine involved, receive prompt notice of any warranty claim and that the engine or the part or parts claimed to be defective be promptly delivered, transportation prepaid, to such distributor or service Center for inspection and repair. All repairs qualifying under this Limited Warranty must be performed by Subaru or one of its authorized Distributors or Service Centers.

WARRANTY PERIODS:

Subaru Four-Cycle, EX and EH Series, 4.3 hp or greater, Gasoline Engines	Limited 5 year Warranty
Subaru Four-Cycle, EH Series, LP/NG Engines	Limited 5 year Warranty
Subaru Mini-Four-Cycle, EH025, EH035, EH035V, Gasoline Engines	Limited 2 year Warranty
Subaru SP170, SP210 Gasoline Engines (Private/Residential)	Limited 3 year Warranty
Subaru SP170, SP210 Gasoline Engines (Commercial)	Limited 1 year Warranty
Subaru Rammer Series, Gasoline Engines	Limited 2 year Warranty
Subaru EA190V, EA175V Gasoline Engines (Private/Residential)	Limited 3 year Warranty
Subaru EA190V, EA175V Gasoline Engines (Commercial)	Limited 1 year Warranty

The repair or replacement of any part or parts under this Limited Warranty shall not extend the term of the engine warranty beyond the original term as set forth above.

LIMITATIONS AND EXCLUSIONS: This Limited Warranty shall not apply to:

1. Bent or broken crankshaft or resultant damage caused by vibration related to a bent or broken crankshaft. Also, damage caused by loose engine mounting bolts or improper or imbalanced accessories or blades mounted to the crankshaft.
2. Repairs required because of prolonged storage including damage caused by old or contaminated fuel in the fuel tank, fuel lines or carburetor, sticky valves or corrosion and rust of engine parts or use of fuel containing more than 10% of ethanol.
3. Repair required due to overheating. (Most often caused by overloaded or clogged or damaged or missing flywheel, fan, inlet air passages, cooling fins or air shrouds.)
4. Dirt or grit related wear caused by improper air cleaner maintenance (most often resulting in worn piston, piston rings, cylinders, valves, valve guides, carburetor or other internal components).
5. Broken or scored parts caused by low oil level, dirty or improper grade of oil.
6. Engine tune-ups and normal maintenance service including, but not limited to, valve adjustment, normal replacement of service items, fuel and lubricating oil, etc.
7. Any engine which has been subject to negligence, misuse, accident, mis-application or over-speeding.
8. Any engine that has been installed, repaired, or altered by anyone in a manner which in Subaru’s sole judgment adversely affects its performance or reliability.
9. Any engine which has been fitted with or repaired with parts or components not manufactured or approved by Subaru which in Subaru’s sole judgment adversely affects its performance or reliability.
10. Instances when normal use has exhausted the life of a component or an engine.

The customer is responsible for all transportation charges in connection with any warranty work.

Subaru reserves the right to modify, alter or improve any engines or parts without incurring any obligation to modify or replace, any engine or parts previously sold without such modification, alternation or improvement.

No person is authorized to give any other warranty or to assume any additional obligation on Subaru’s behalf unless made in writing and signed by an officer of Subaru.

THIS WARRANTY, AND SUBARU’S OBLIGATION HERE UNDER, ARE IN LIEU OF ANY OTHER WARRANTIES OR OBLIGATIONS OF ANY KIND, EXPRESSED OR IMPLIED, INCLUDING ANY WARRANTIES OF MERCHANTABILITY OR FITNESS FOR A PARTICULAR PURPOSE. THERE ARE NO WARRANTIES WHICH EXTEND BEYOND THE DESCRIPTION ON THE FACE HERE-OF. SUBARU SHALL IN NO EVENT BE LIABLE FOR ANY CONSEQUENTIAL OR INCIDENTAL DAMAGES.

Notice: FEDERAL EMISSION COMPONENT DEFECT WARRANTY applies only to engines sold in the United States and U.S. Territories.

Notice: To the engines/generators exported to and used in the countries other than the U.S.A., warranty service shall be performed by the distributor in each country in accordance with the standard Subaru engine/generator warranty policy as applicable.

FEDERAL EMISSIONS COMPONENT DEFECT WARRANTY

EMISSIONS COMPONENT DEFECT WARRANTY COVERAGE - This emission warranty is applicable in all States, except the State of California.

Fuji Heavy Industries Ltd. and Robin America Inc., 905 Telser Road, Lake Zurich, Illinois 60047, (herein "ROBIN AMERICA") warrant(s) to the initial retail purchaser and each subsequent owner, that this Nonroad engine (herein "engine") has been designed, built, and equipped to conform at the time of initial sale to all applicable regulations of the U.S. Environmental Protection Agency (EPA), and that the engine is free of defects in materials and workmanship which would cause this engine to fail to conform with EPA regulations during its warranty period.

For the components listed under PARTS COVERED, the service dealer authorized by ROBIN AMERICA will, at no cost to you, make the necessary diagnosis, repair, or replacement necessary to ensure that the engine complies with applicable U.S. EPA regulations.

EMISSION COMPONENT DEFECT WARRANTY PERIOD

The warranty period for this engine begins on the date of sale to the initial purchaser and continues for a period of five years.

PARTS COVERED

Listed below are the parts covered by the Emission Components Defect Warranty. Some of the parts listed below may require scheduled maintenance and are warranted up to the first scheduled replacement point for that part.

EXHAUST EMISSIONS

- (1) Fuel Metering System
 - (i) Carburetor and internal parts (and/or pressure regulator or fuel injection system).
 - (ii) Air/fuel ratio feedback and control system, if applicable.
 - (iii) Cold start enrichment system, if applicable.
 - (iv) Regulator assy (gaseous fuel, if applicable)
- (2) Air Induction System
 - (i) Intake manifold, if applicable
 - (ii) Air filter.
- (3) Ignition System
 - (i) Spark plugs.
 - (ii) Magneto or electronic ignition system.
 - (iii) Spark advance/retard system, if applicable.
- (4) Catalyst or Thermal Reactor System
 - (i) Catalytic Converter, if applicable
 - (ii) Thermal Reactor, if applicable
 - (iii) Exhaust Manifold, if applicable
- (5) Miscellaneous Items Used in Above Systems
 - (i) Electronic controls, if applicable
 - (ii) Hoses, belts, connectors, and assemblies.
 - (iii) Filter lock assy (gaseous fuel, if applicable)

EVAPORATIVE EMISSIONS

- (1) Fuel Line
- (2) Fuel Line Fittings
- (3) Clamps
- (4) Fuel Tank
- (5) Fuel Cap
- (6) Vapor Hoses
- (7) Carbon Canister
- (8) Carbon Canister Mounting Brackets
- (9) Air Cleaner Purge Port Connector

*Fuji is not liable for the warranty on these parts if these parts are prepared and equipped by the equipment manufacturer. Please refer to the equipment manufacturer's warranty.

REPLACEMENT PARTS DISTRIBUTION CENTER

Replacement parts are provided to the market upon request by the customers. Replacement parts distribution center is located at Robin America Inc., 905 Telser Road, Lake Zurich, Illinois 60047. If you have a question regarding your replacement part, you should contact Robin America Inc. at 1-800-277-6246 (toll-free phone number) website.warranty@robinamerica.com (e-mail address)

OBTAINING WARRANTY SERVICE

To obtain warranty service, take your engine to the nearest authorized Robin America service dealer. Bring your sales receipts indicating date of purchase for this engine. The service dealer authorized by ROBIN AMERICA will perform the necessary repairs or adjustments within a reasonable amount of time and furnish you with a copy of the repair order. All parts and accessories replaced under this warranty become the property of ROBIN AMERICA.

FUJI HONOR WARRANTY CLAIMING

For owners located more than 100 miles from an authorized service center, the following will be provided to those applicable owners. (excluding the states with high-altitude areas)

- * Fuji will either pay for the shipping costs of replacement parts to and from an authorized service center.
- * Or Fuji will provide for a service technician to come to the owner to make the warranty repair.
- * Or Fuji will pay for the repair to be made at a local nonauthorized service center.

WHAT IS NOT COVERED

- * Conditions resulting from tampering, misuse, improper adjustment (unless they were made by the service dealer authorized by ROBIN AMERICA during a warranty repair), alteration, accident, failure to use the recommended fuel and oil, or not performing required maintenance services.
- * The replacement parts used for required maintenance services.
- * Consequential damages such as loss of time, inconvenience, loss of use of the engine or equipment, etc.
- * Diagnosis and inspection charges that do not result in warranty-eligible service being performed.
- * Any non-authorized replacement part, or malfunction of authorized parts due to use of non-authorized parts.

FEDERAL EMISSIONS COMPONENT DEFECT WARRANTY cont.

OWNER'S WARRANTY RESPONSIBILITIES

As the engine owner, you are responsible for the performance of the required maintenance listed in your owner's manual.

ROBIN AMERICA recommends that you retain all receipts covering maintenance on your engine, but ROBIN AMERICA cannot deny warranty solely for the lack of receipts or for your failure to ensure the performance of all scheduled maintenance.

As the engine owner, you should however be aware that ROBIN AMERICA may deny warranty coverage if your engine or a part has failed due to abuse, neglect, improper maintenance or unapproved modifications.

You are responsible for presenting your engine to the nearest service dealer authorized by ROBIN AMERICA when a problem exists.

If you have any questions regarding your warranty rights and responsibilities, you should contact the Robin America customer service department at 1-800-277-6246 (toll-free phone number) website.warranty@robinamerica.com (e-mail address) for the information.

THINGS YOU SHOULD KNOW ABOUT THE EMISSION CONTROL SYSTEM WARRANTY MAINTENANCE AND REPAIRS

You are responsible for the proper maintenance of the engine. You should keep all receipts and maintenance records

covering the performance of regular maintenance in the event questions arise. These receipts and maintenance records should be transferred to each subsequent owner of the engine. ROBIN AMERICA reserves the right to deny warranty coverage if the engine has not been properly maintained. Warranty claims will not be denied, however, solely because of the lack of required maintenance or failure to keep maintenance records.

MAINTENANCE, REPLACEMENT OR REPAIR OF EMISSION CONTROL DEVICES AND SYSTEMS MAY BE PERFORMED BY ANY REPAIR ESTABLISHMENT OR INDIVIDUAL; HOWEVER, WARRANTY REPAIRS MUST BE PERFORMED BY A SERVICE DEALER AUTHORIZED BY ROBIN AMERICA. THE USE OF PARTS THAT ARE NOT EQUIVALENT IN PERFORMANCE AND DURABILITY TO AUTHORIZED PARTS MAY IMPAIR THE EFFECTIVENESS OF THE EMISSION CONTROL SYSTEM AND MAY HAVE A BEARING ON THE OUTCOME OF A WARRANTY CLAIM.

If other than the parts authorized by ROBIN AMERICA are used for maintenance replacements or for the repair of components affecting emission control, you should assure yourself that such parts are warranted by their manufacturer to be equivalent to the parts authorized by ROBIN AMERICA in their performance and durability.

HOW TO MAKE A CLAIM

All repairs qualifying under this limited warranty must be performed by a service dealer authorized by ROBIN

AMERICA. In the event that any emission-related part is found to be defective during the warranty period, you shall notify Robin America customer service department at 1-800-277-6246 (toll-free phone number) website.warranty@robinamerica.com (e-mail address) and you will be advised of the appropriate warranty service dealer or service providers where the warranty repair can be performed.

